

**Series 70 eSTS**  
 1600A, 2-source, 3-pole, 3-wire, 65kA, SMR

CIRCUIT BREAKER DATA								
REF NO	RATING	FAULT RATING	TYPE	MOUNTING	AUXILIARY CONTACTS	SHUNT TRIPS	MFG	BREAKER SERIES
CB101 CB201 CB102 CB202	2000AF	125kA @ 480VAC (per UL ratings)	Molded Case Switch 3-pole	Fixed	Yes Internal Use Only	No	ABB	Tmax T8
CB301 CB302	2000AF	125kA @ 480VAC (per UL ratings)	Molded Case Switch 3-pole	Fixed	Yes Internal Use Only	No	ABB	Tmax T8

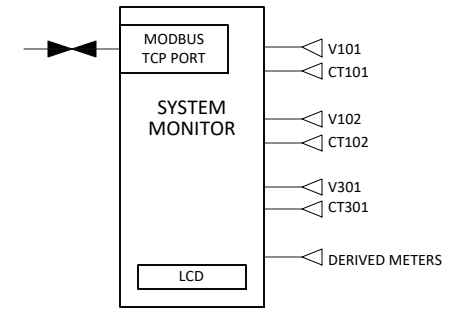
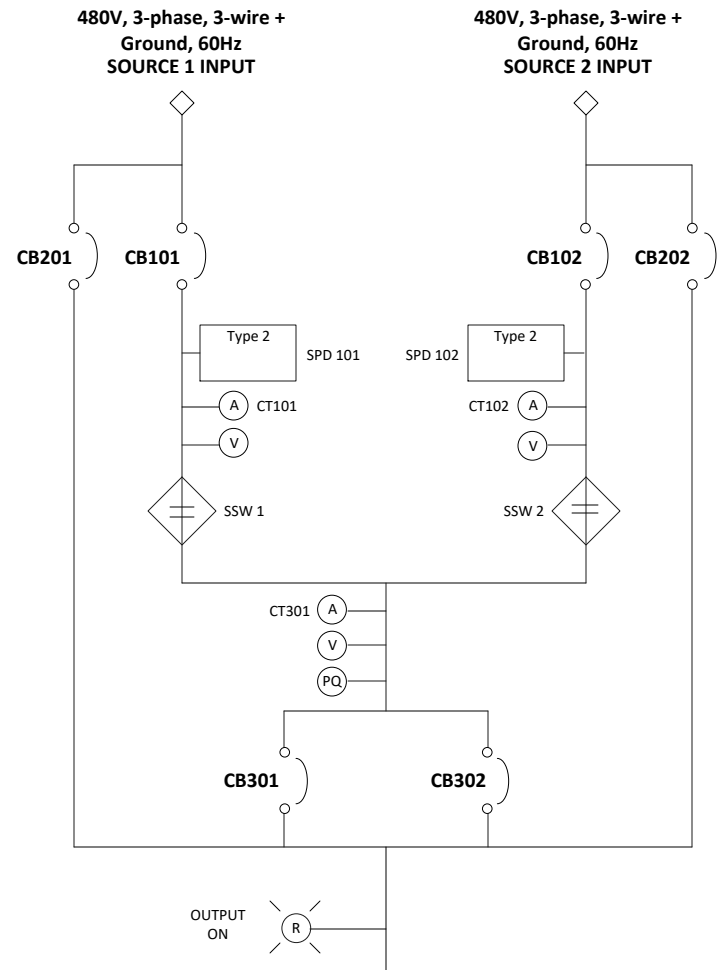

NOTE:  
 REFER TO THE MECHANICAL OUTLINE DRAWING FOR INFORMATION ON THE CUSTOMER CONNECTION TERMINALS.

LEGEND				
(A)	CURRENT METERING POINT			
(V)	VOLTAGE METERING POINT			
(PQ)	POWER QUALITY METERING POINT			

			PAGE DESCRIPTION	
			ONE LINE DIAGRAM, eSTS	
JOB	DRAWN	DATE 6/20/2023	DWG NO	REV
	CHK	DATE	eSTS000561	A
	APPR	DATE	SHEET 1 OF 2	

# CUSTOMER INTERFACE BOARD (CIB)

## EXTERNAL CONTROL CONTACTS

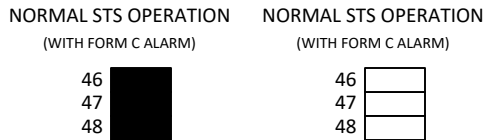
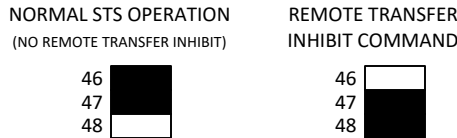
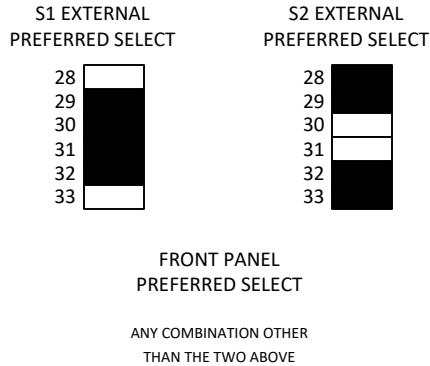

■ SYMBOL FOR CLOSED CONTACTS

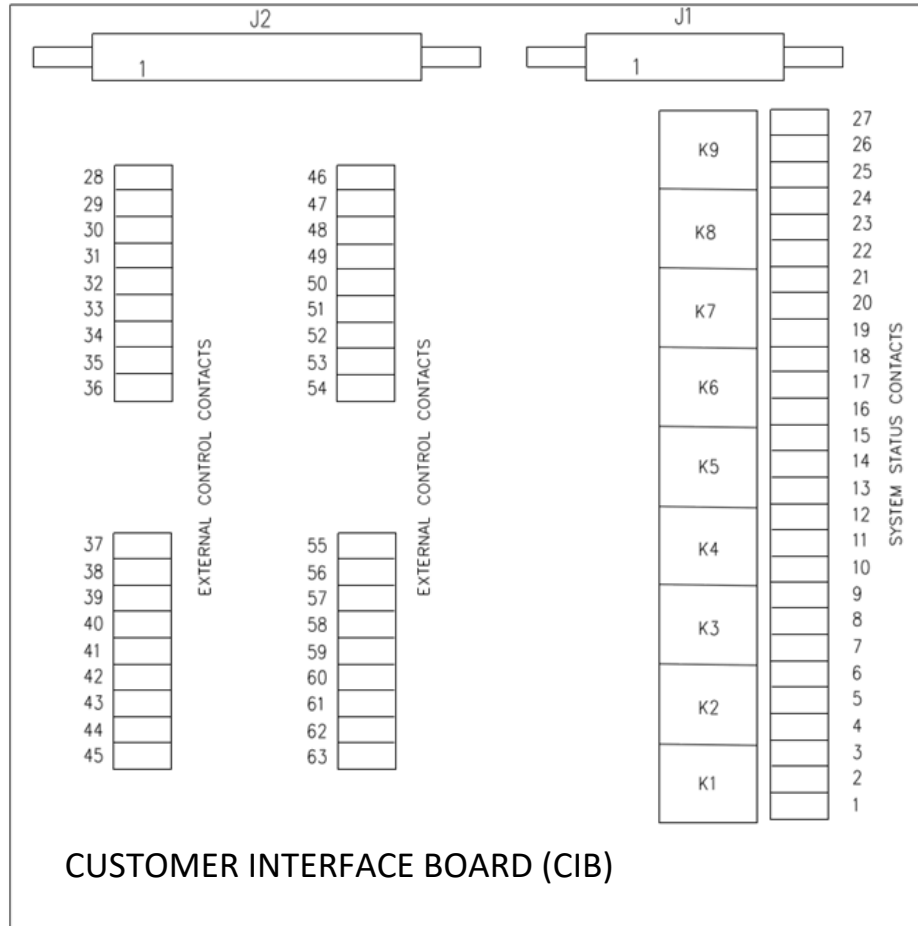

## CUSTOMER INTERFACE BOARD (CIB)

## SYSTEM STATUS CONTACTS

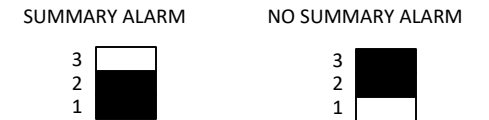
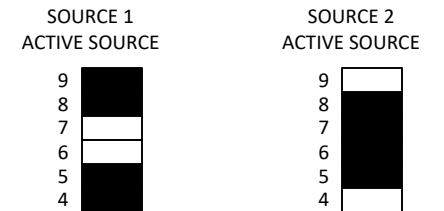
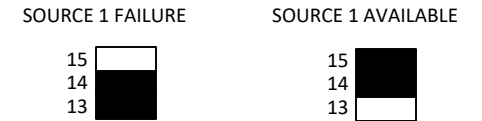
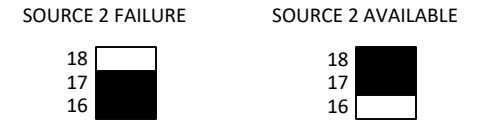
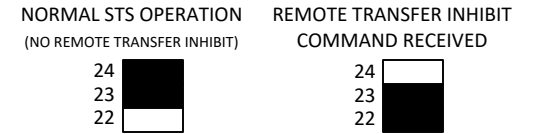

### NOTES:

1. TERMINAL NUMBERS REFER TO TERMINALS ON CUSTOMER INTERFACE BOARD (CIB). REFER TO THE MECHANICAL OUTLINE DRAWING FOR EXACT LOCATION OF THE CIB AND CUSTOMER WAN.

2. TERMINALS SUITABLE FOR AWG 20-16 STRANDED COPPER WIRE. MAXIMUM ONE WAY LENGTH FOR #16: 500 ft (152 m).

3. ALL WIRING TO BE IN ACCORDANCE WITH THE NATIONAL ELECTRIC CODE AND ALL LOCAL CODES. CONTROL AND STATUS WIRING MUST BE RUN AND IN SEPARATE CONDUIT FROM POWER WIRING.

4. SYSTEM STATUS OUTPUTS ARE DRY, POTENTIAL-FREE CONTACTS. CUSTOMER REQUIREMENTS ARE AS FOLLOWS:  
 a. Circuit voltage  $V < 250$  V AC with current  $I < 12$  A RMS, power factor = 1.0.  
 b. Circuit voltage  $V < 200$  V DC with current  $I < 0.4$  A.

5. SYSTEM CONTROL INPUTS READ COMMANDS FROM EXTERNAL CONTACTS. CUSTOMER REQUIREMENTS ARE AS FOLLOWS:  
 a. Dry, potential-free contacts.  
 b. Form C  
 c. Contacts are to be capable of switching 24 V DC at 5 mA  $< I < 10$  mA.

			PAGE DESCRIPTION	
			ONE LINE DIAGRAM, eSTS	
JOB	DRAWN	DATE 6/20/2023	DWG NO	REV
	CHK	DATE	eSTS000561	A
	APPR	DATE	SHEET 2 OF 2	